



CHINA WELFARE LOTTERY
中国福利彩票实体店
设计方案

STORE IDENTITY SYSTEM

目录 | CONTENTS

A-1 特装型店铺设计----U型户外店

1 内部功能分区图及动线	03
2 功能模块布置说明图	04
3 效果图	05
4 造型比例尺寸规范	16

A-2 传统型店铺设计

1 内部功能分区图及动线	31
2 功能模块布置说明图	32
3 效果图	33
4 造型比例尺寸规范	38

A-3 "O"型岛型店

1 内部功能分区图及动线	53
2 功能模块布置说明图	54
3 效果图	55
4 造型比例尺寸规范	61



A-1 | 特装型店铺设计

U型户外店

A-1 类型说明

三面开窗，
人流只能从前、左、右
三面行经

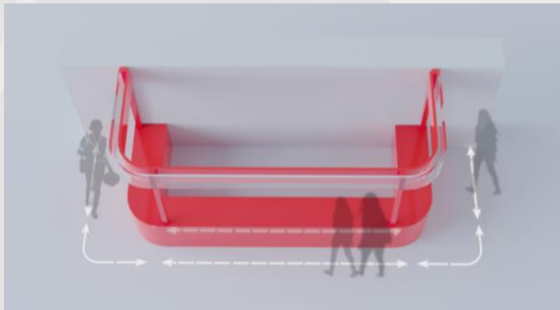

A-1.1 内部功能分区图及动线

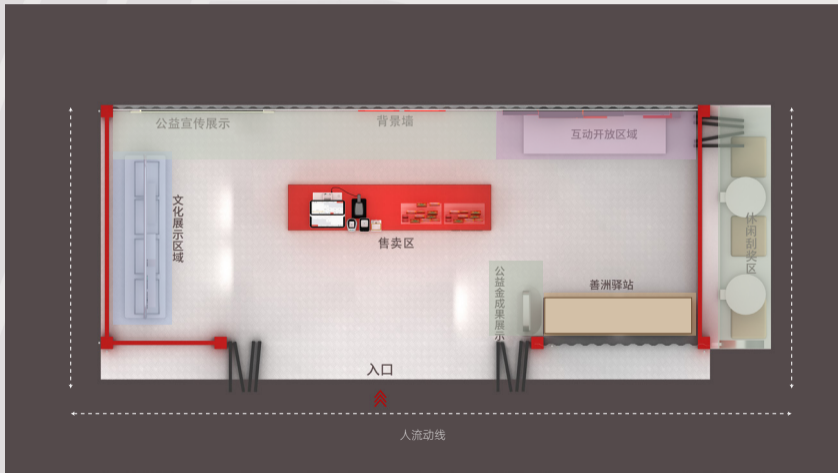

A-1.2 功能模块布置说明图



A-1.3 效果图示意 外观斜45度侧面日常效果



A-1.3 效果图示意 外观斜45度侧面夜晚带灯光效果



A-1.3 效果图示意 外观正面日常效果



A-1.3 效果图示意 外观正面夜晚带灯光效果



A-1.3 效果图示意 外观侧面日常效果



A-1.3 效果图示意 外观侧面夜晚带灯光效果



霓虹灯带效果

A-1.3 效果图示意 内部背景墙+销售区+公益角+互动开放区域效果图



A-1.3 效果图示意 文化展示+多媒体+宣传展示效果图



A-1.3 效果图示意 善洲驿站区域



A-1.3 效果图示意 公益金成果展示区域+销售区效果图



A-1.4 造型比例尺寸规范 平面功能图

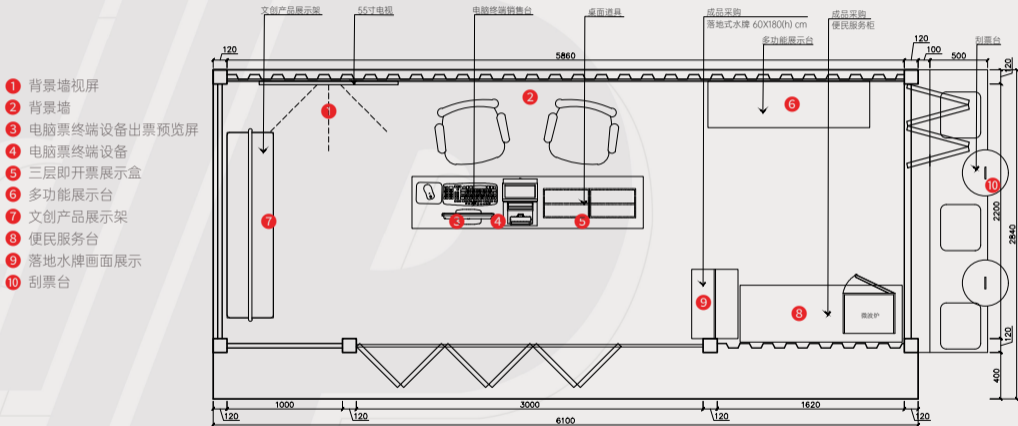

A-1.4 造型比例尺寸规范 地面铺装图

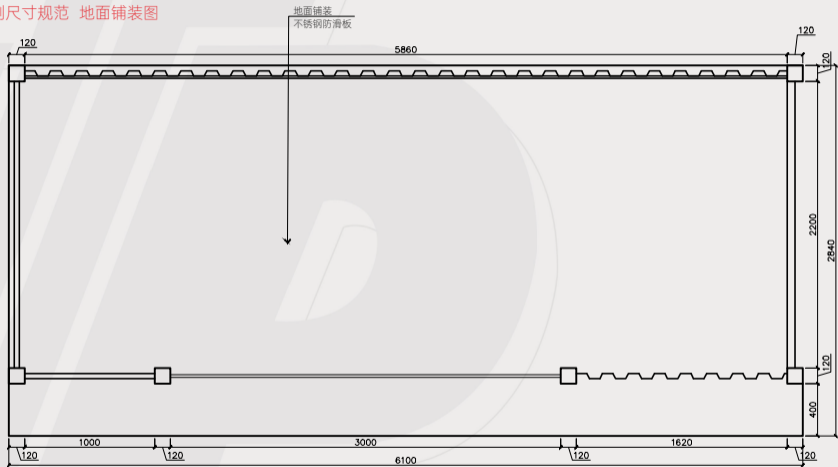

A-1.4 造型比例尺寸规范 立面索引图

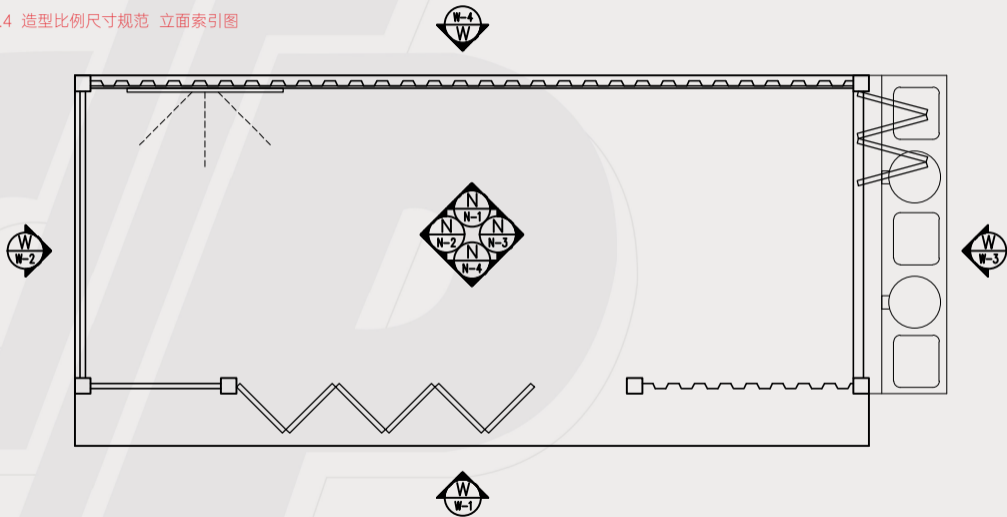

A-1.4 造型比例尺寸规范 立面图尺寸图

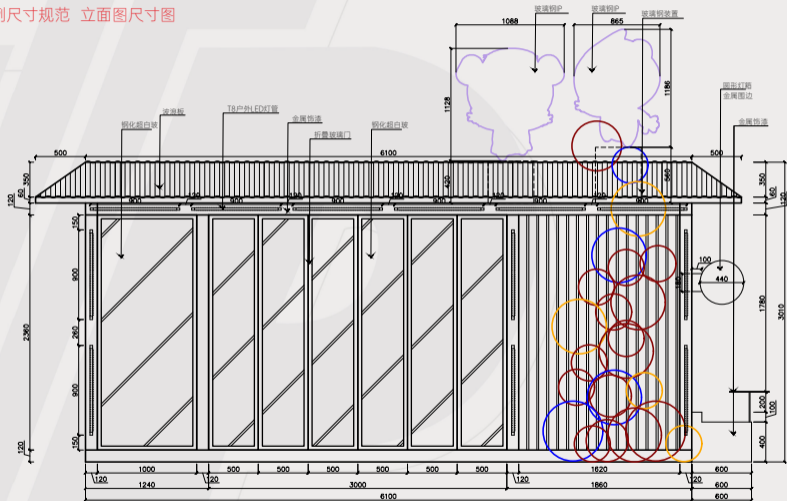

W-1立面图

A-1.4 造型比例尺寸规范 立面图尺寸图

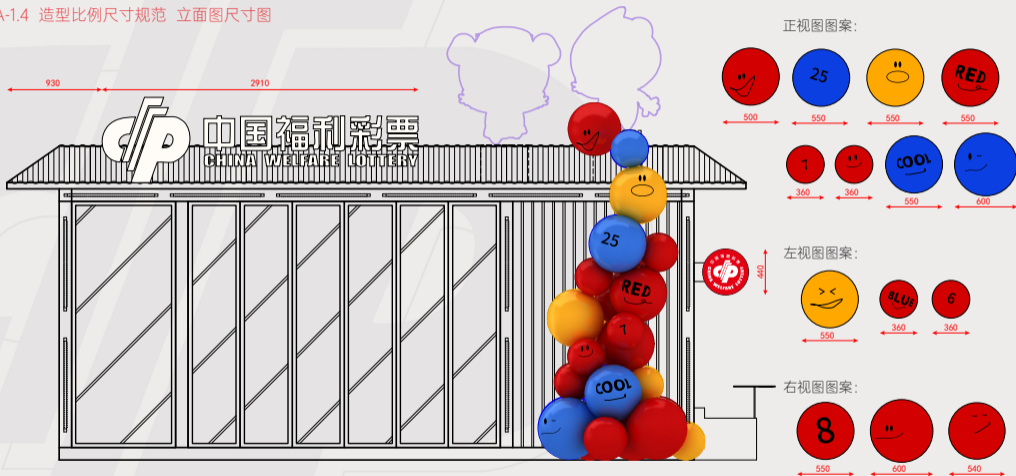

W-1立面图

A-1.4 造型比例尺寸规范 立面图尺寸图

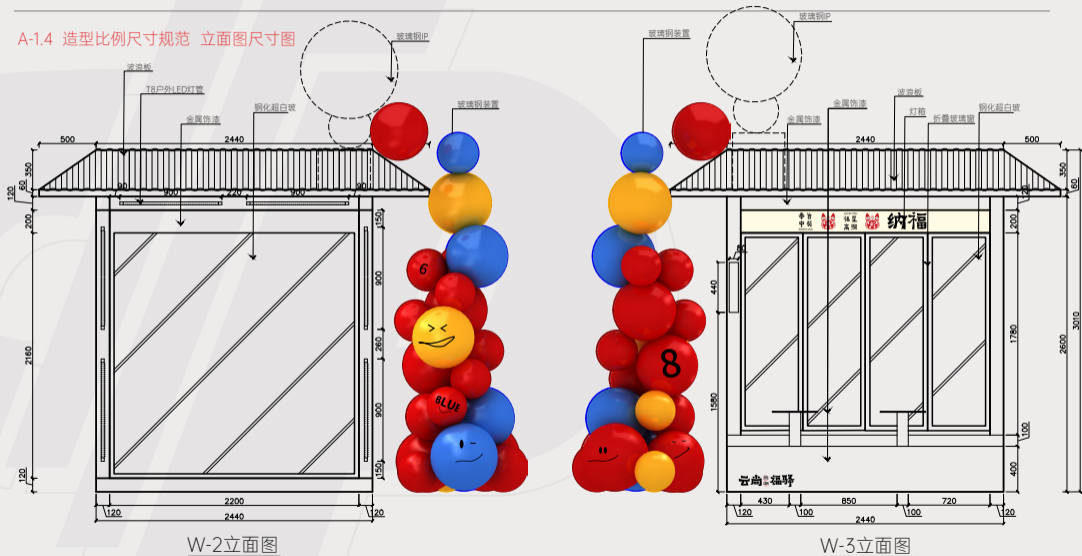

A-1.4 造型比例尺寸规范 立面图尺寸图

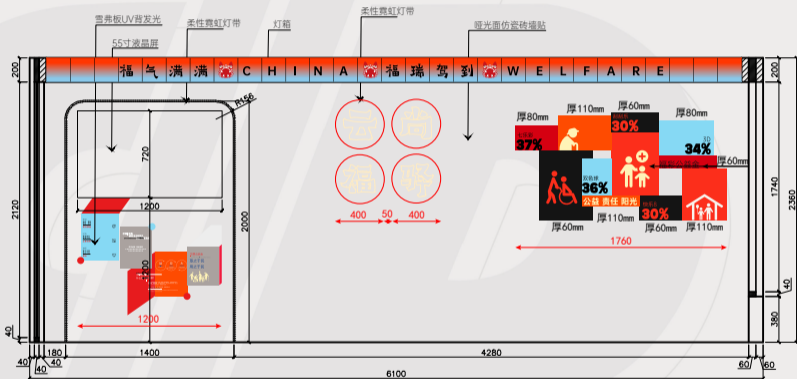

N-1 立面图

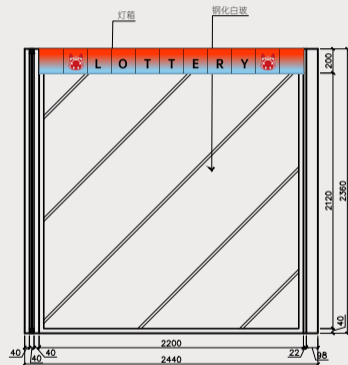

N-2 立面图

A-1.4 造型比例尺寸规范 立面图尺寸图

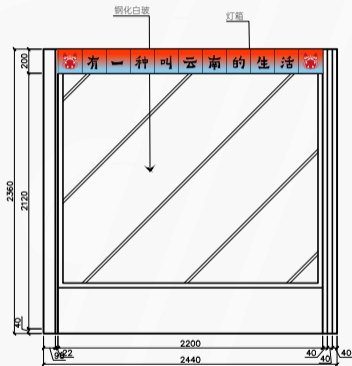

N-3立面图

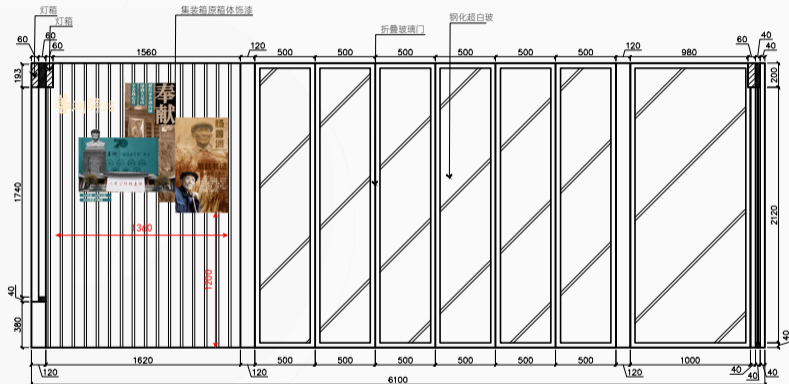

N-4立面图

A-1.4 造型比例尺寸规范 文创产品展示架尺寸图

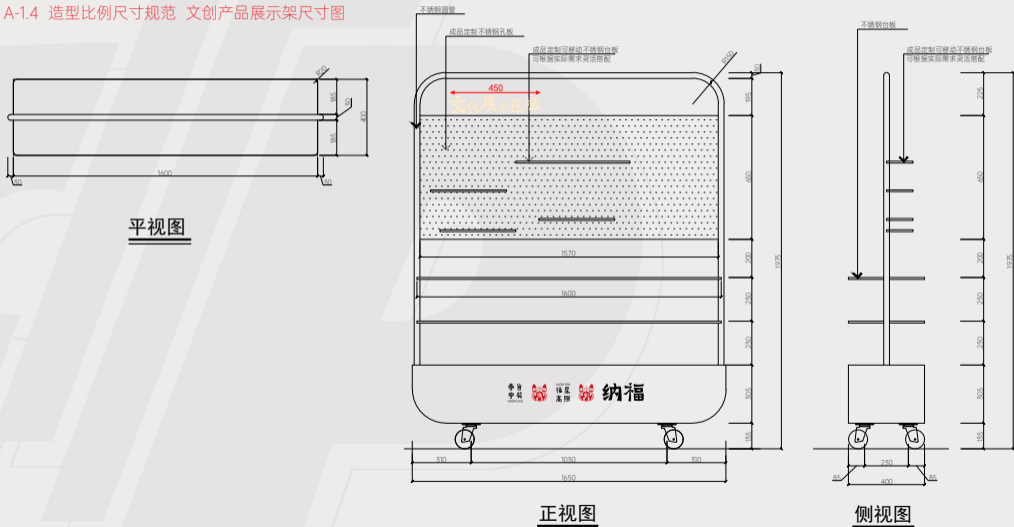



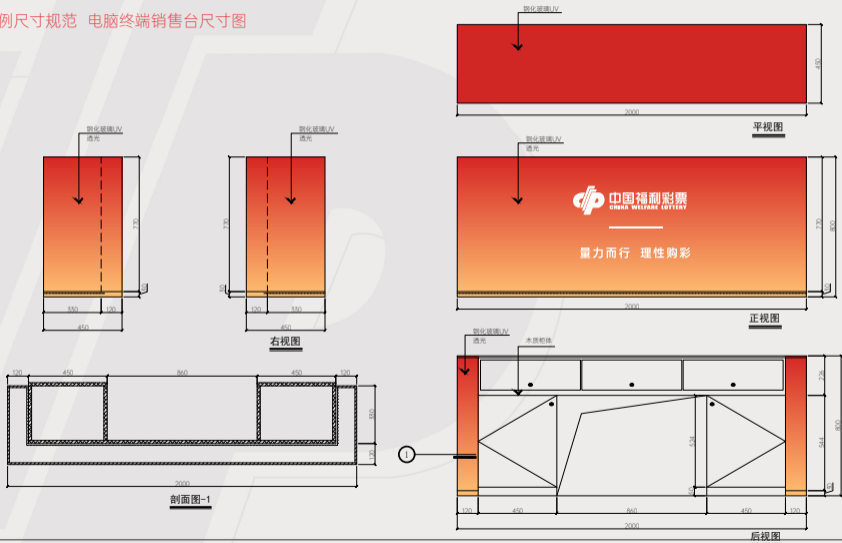

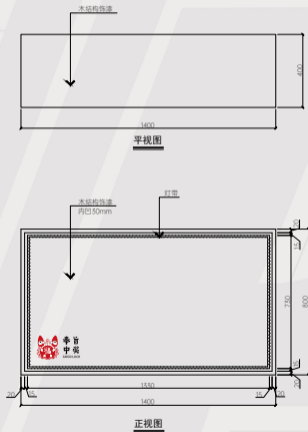

A-1.4 造型比例尺寸规范 电脑终端销售台尺寸图

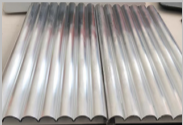

A-1.4 造型比例尺寸规范 多功能展示台、指引牌尺寸图



A-1.4 造型比例尺寸规范 特殊材质说明表

	示意图	名称		
外立面 材质颜色		 <p>波浪板饰漆</p>	 <p>T8户外LED灯管</p>	 <p>玻璃钢雕塑</p>
内部 材质颜色		 <p>哑光面仿瓷砖墙贴</p>	 <p>渐变玻璃透光</p>	 <p>不锈钢洞洞板</p>



A-2 | 传统型店铺设计

A-2.1 内部功能分区图及动线

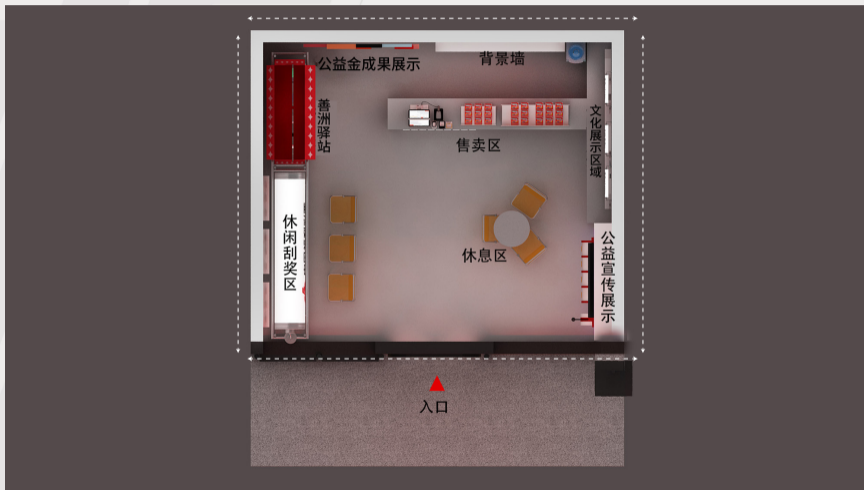

A-2.1 内部功能分区图及动线

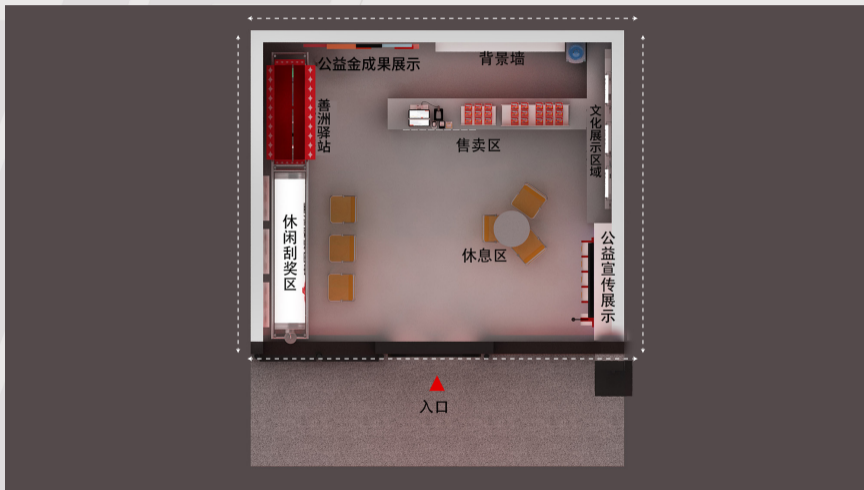

A-2.3 效果图示意 外观正面夜晚带灯光效果



A-2.3 效果图示意 刮奖区+销售区+公益金成果展示+善洲驿站效果图



A-2.3 效果图示意 内部总览图



A-2.3 效果图示意 形象墙+文化展示+多媒体公益宣传效果图



A-2.4 造型比例尺寸规范 平面功能图

- ① 背景墙
- ② 背景墙墙挂电视
- ③ 电脑票终端设备出票预览屏
- ④ 电脑票终端设备
- ⑤ 三层即开票展示盒
- ⑥ 宣传资料展示架
- ⑦ 文创产品展示架
- ⑧ 便民服务台
- ⑨ 即开票展示架
- ⑩ 刮票台

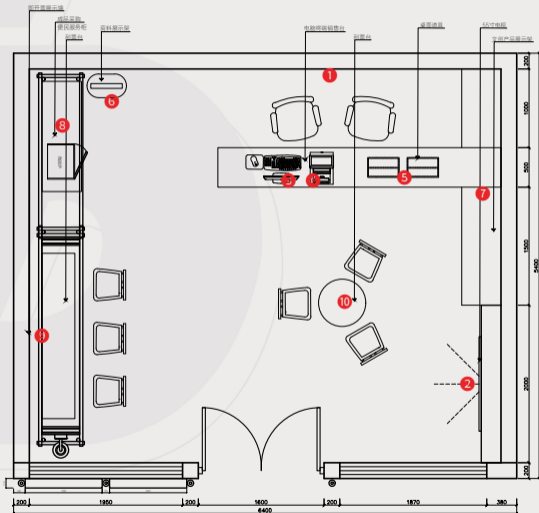

A-2.4 造型比例尺寸规范 天花布局图

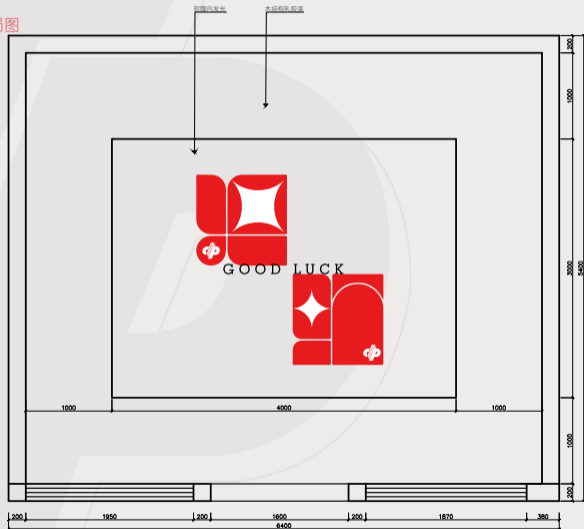

A-2.4 造型比例尺寸规范 立面索引图

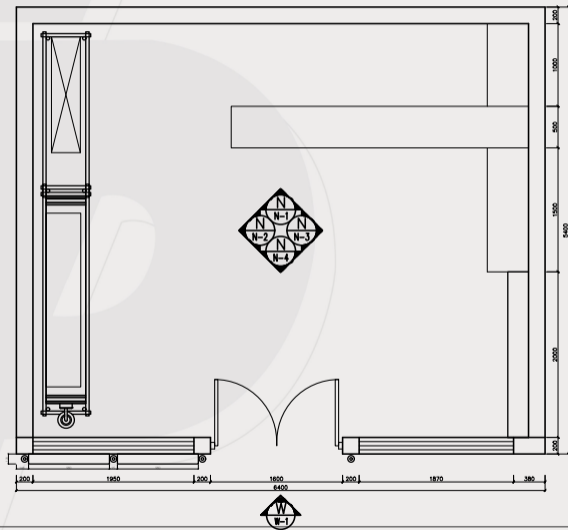

A-2.4 造型比例尺寸规范 立面图尺寸图

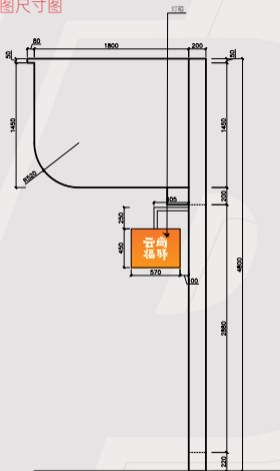

右视图

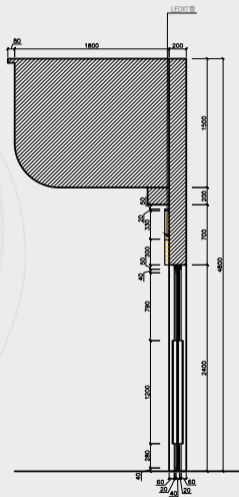

剖面图-1

A-2.4 造型比例尺寸规范
立面图尺寸图

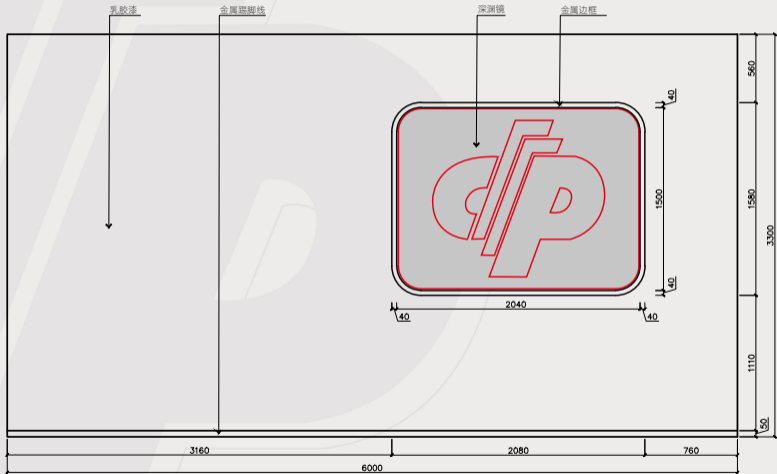

N-1立面图

A-2.4 造型比例尺寸规范
立面图尺寸图

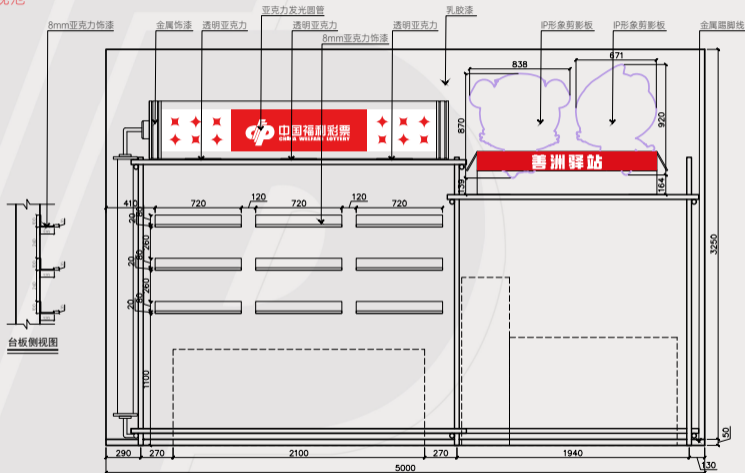

N-2立面图

A-2.4 造型比例尺寸规范 立面图尺寸图

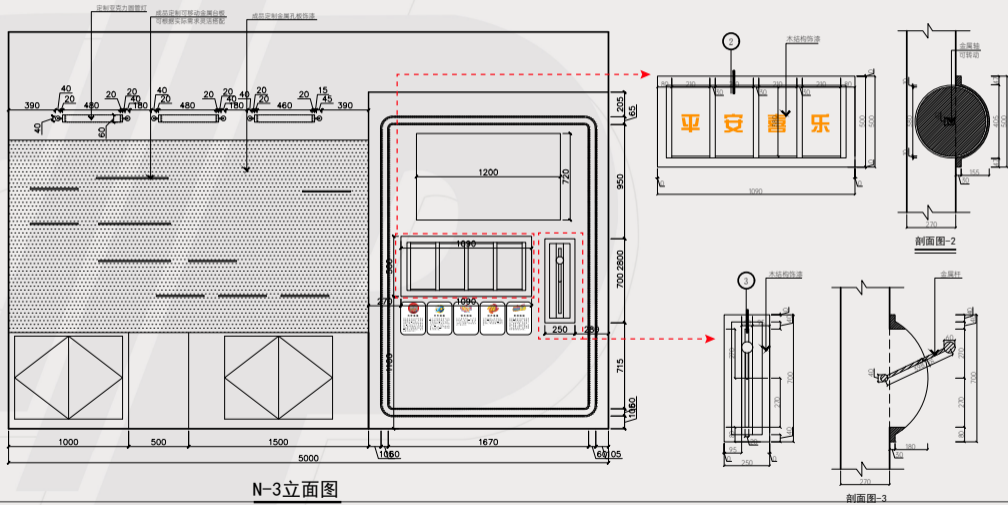

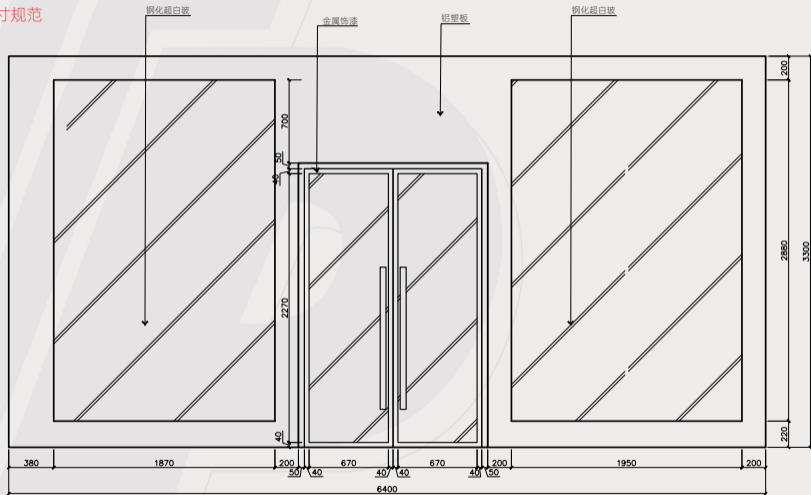
A-2.4 造型比例尺寸规范
立面图尺寸图

N-4立面图

A-2.4 造型比例尺寸规范
即开票展示架-刮票台尺寸图

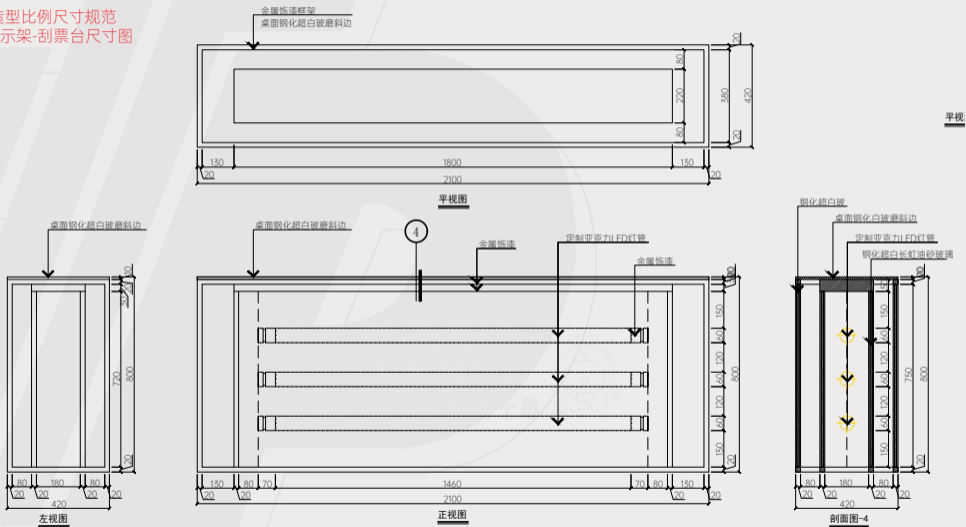

A-2.4 造型比例尺寸规范
电脑终端销售台尺寸图

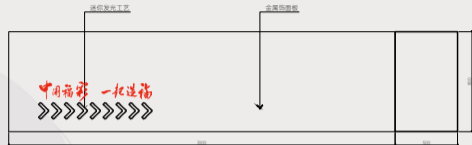
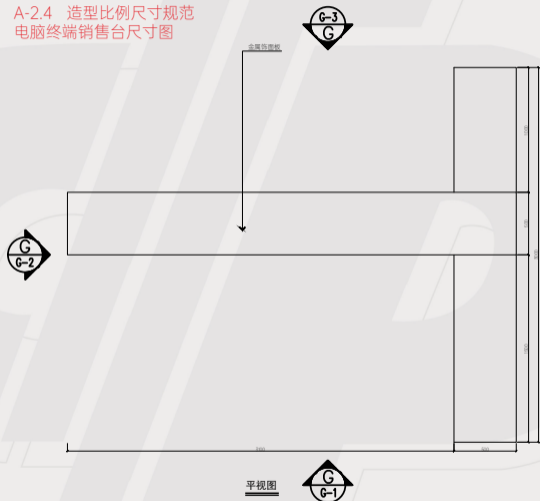

G-1立面图

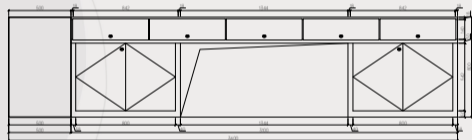

G-3立面图

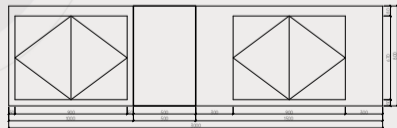

G-2立面图

A-2.4 造型比例尺寸规范 资料展示架、善洲驿站尺寸图

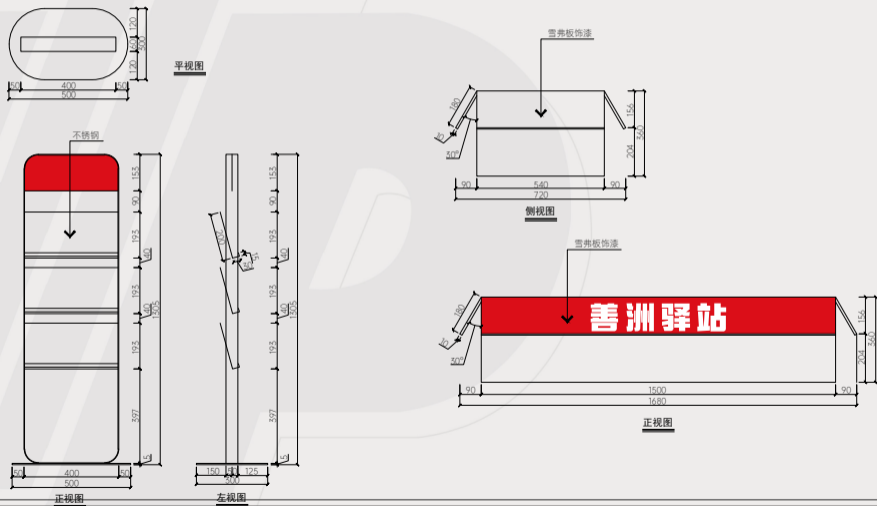

A-2.4 造型比例尺寸规范 特殊材质说明表

	示意图	名称		
<p>外立面 材质颜色</p>		 <p>户外LED灯管</p>		
<p>内部 材质颜色</p>		 <p>不锈钢脚架展架</p>	 <p>深渊镜</p>	 <p>不锈钢洞洞板</p>
		 <p>360度发光亚克力灯管</p>	 <p>长虹油砂玻璃</p>	



A-3 | “O”型岛型店

A-3.1 内部功能分区图及动线

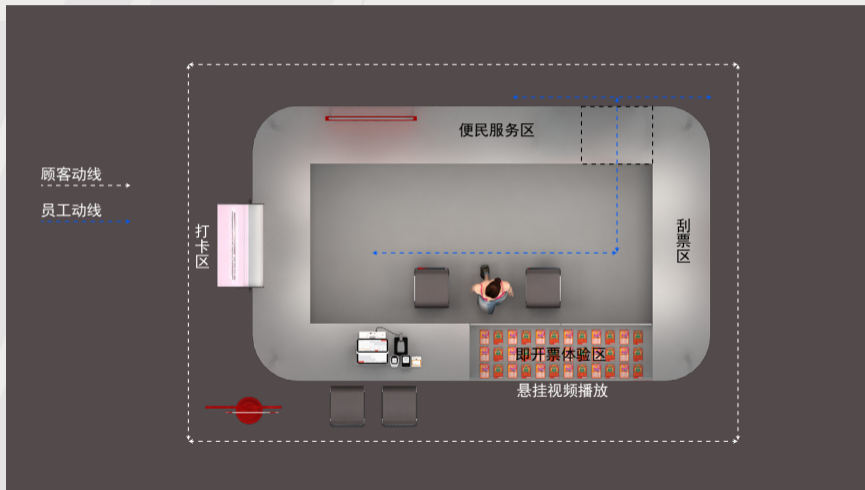

A-3.1 功能模块布置说明图

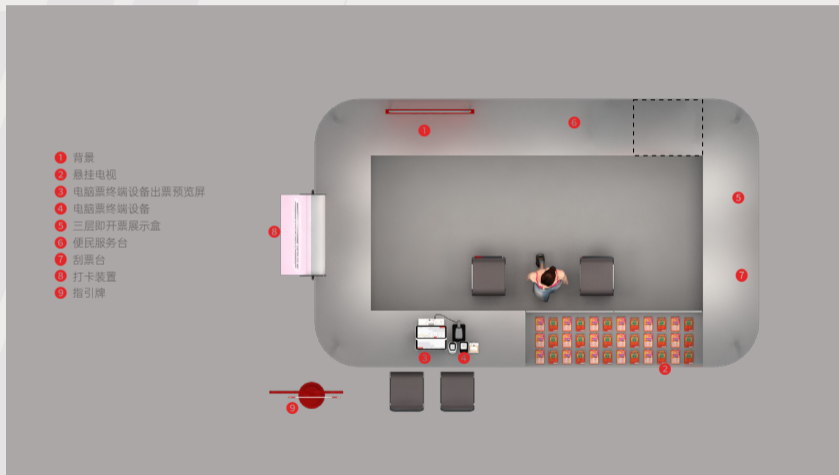

A-3.3 效果图示意 外观正面日常效果



A-3.3 效果图示意 外观正面夜晚带灯光效果

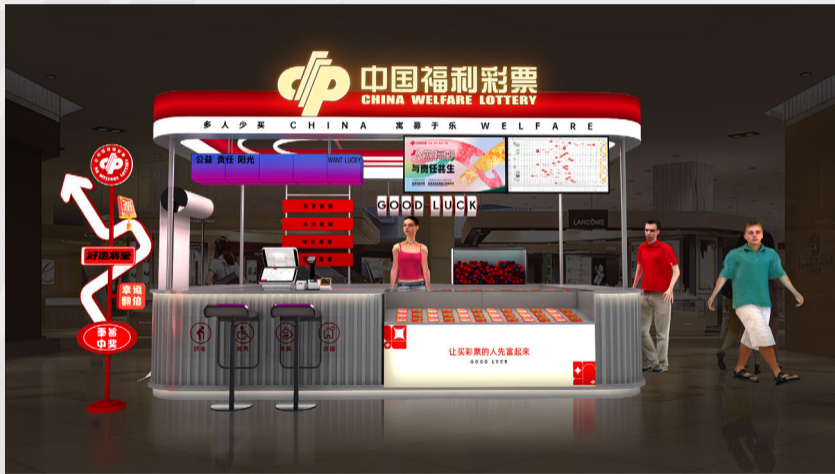

A-3.3 效果图示意 外观斜45度侧面日常效果

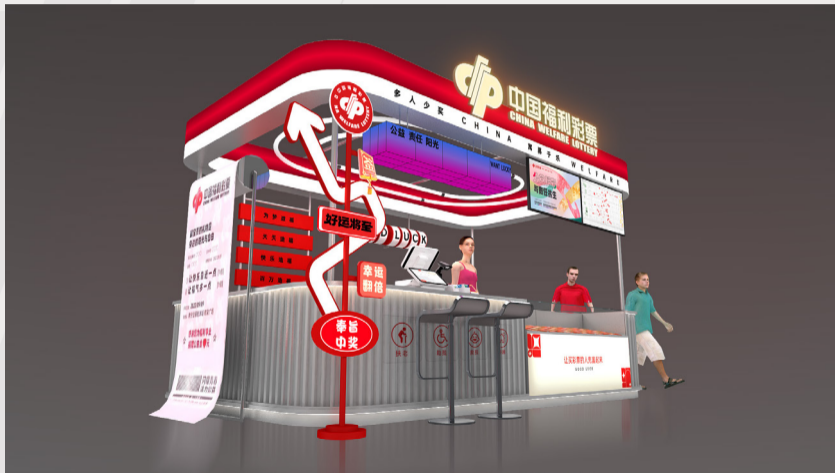

A-3.3 效果图示意 外观斜45度侧面夜晚带灯光效果



A-3.3 效果图示意 外观斜45度侧面日常效果

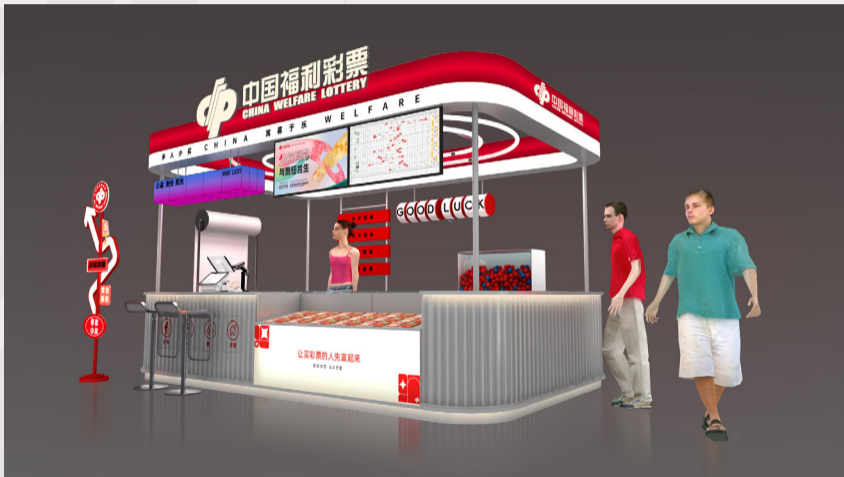

A-3.3 效果图示意 外观斜45度侧面夜晚带灯光效果

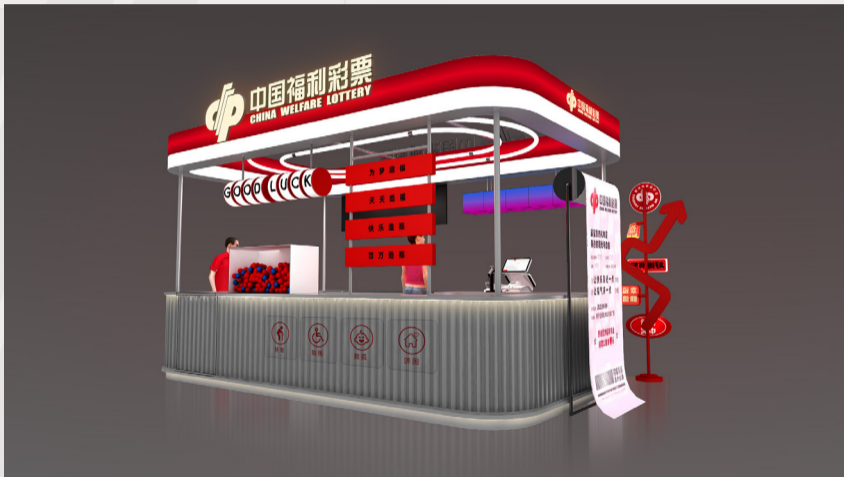

A-3.4 造型比例尺寸规范 平面功能图

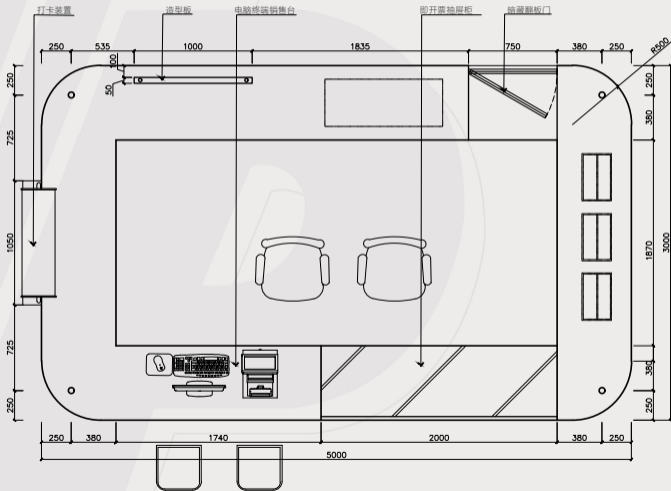

A-3.4 造型比例尺寸规范 天花布局图

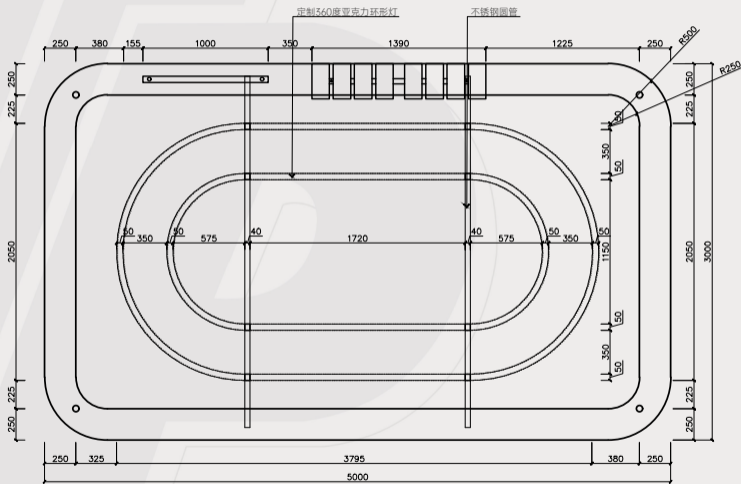

A-3.4 造型比例尺寸规范 立面索引图

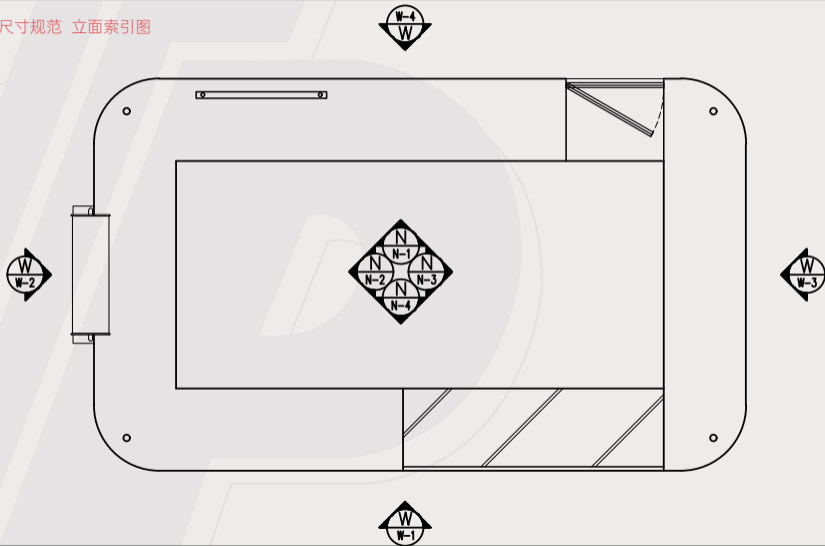

A-3.4 造型比例尺寸规范 立面图尺寸图

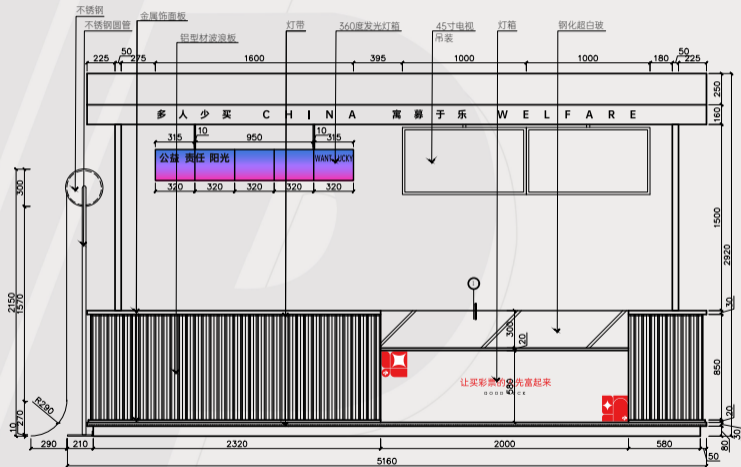

W-1立面图

A-3.4 造型比例尺寸规范 立面图尺寸图

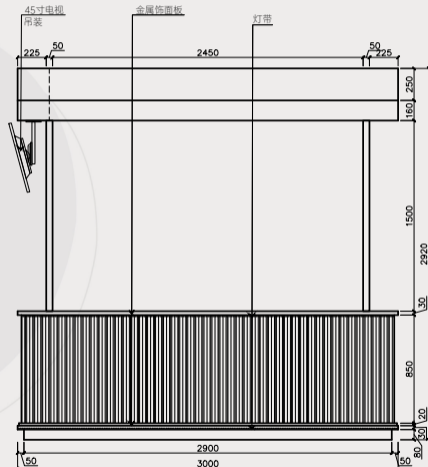
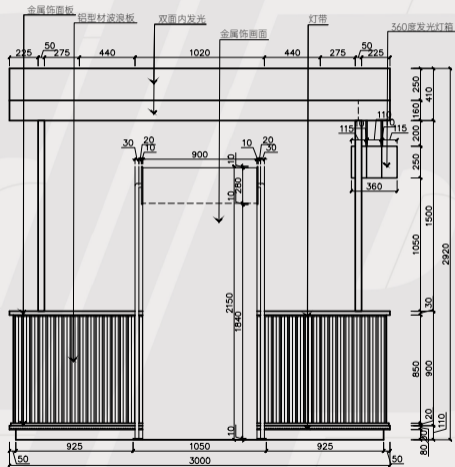

A-3.4 造型比例尺寸规范 立面图尺寸图

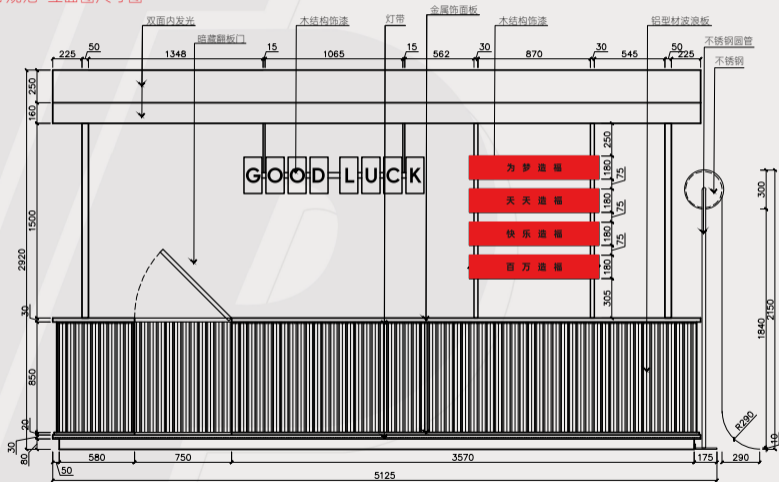

W-4立面图

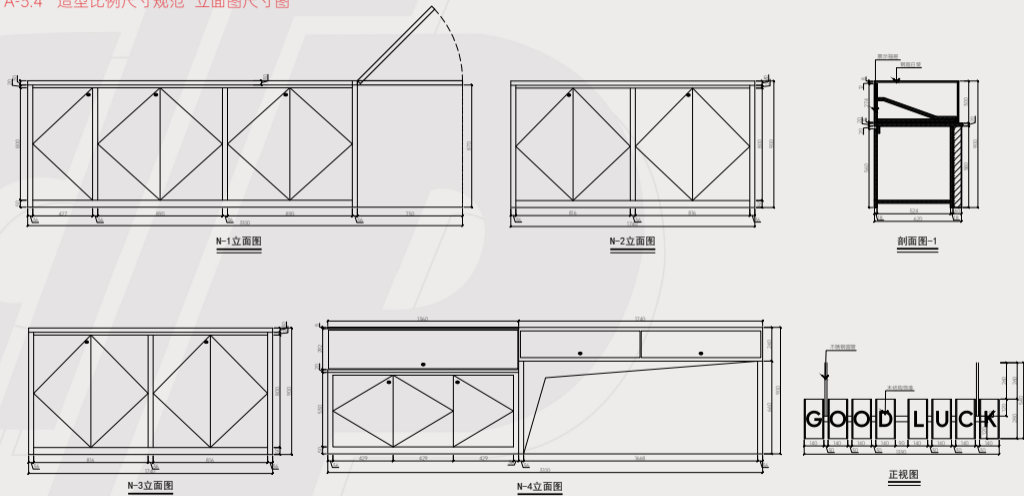

A-3.4 造型比例尺寸规范 立面图尺寸图



A-3.4 造型比例尺寸规范 指引牌尺寸图

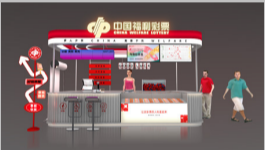

A-3.4 造型比例尺寸规范 特殊材质说明表

	示意图	名称	
材质颜色		 <p>铝型材波浪板</p>	 <p>360度亚克力烤弯灯管</p>

